

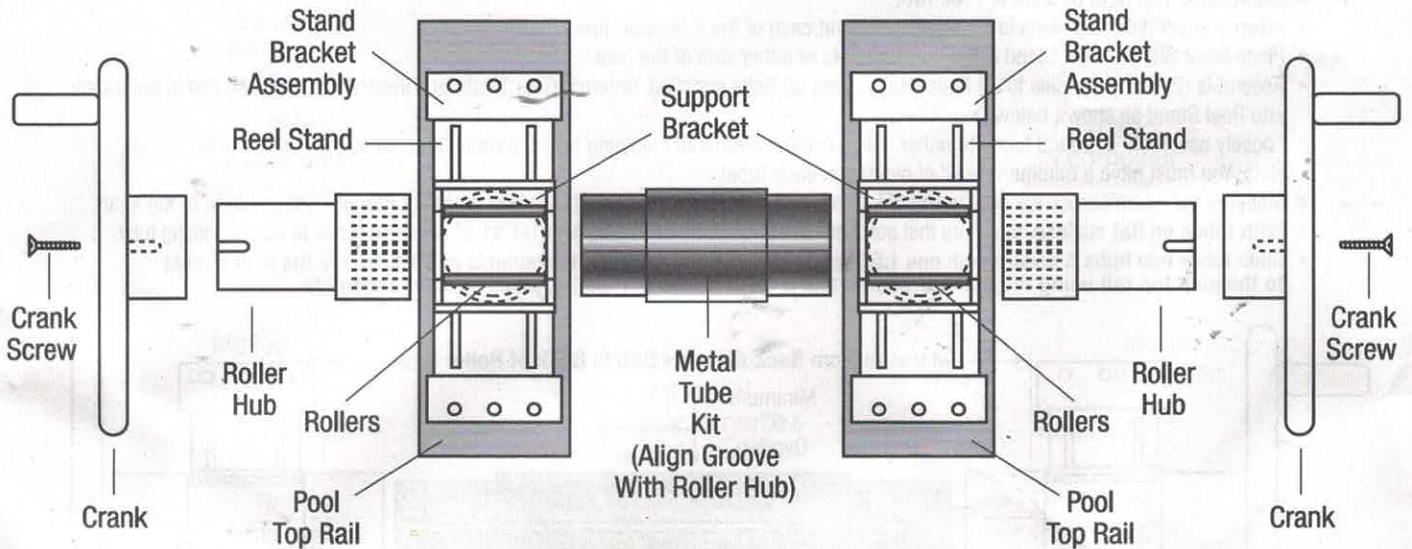







1. Congratulations on your purchase of our Swimline Hydrottools Solar Reel System for Above Ground Pools. Please follow the instructions carefully so as to not void your warranty.
2. Please use your solar blanket and reel assembly in the manner it was intended for:
 - a. Your solar blanket is not a safety cover
 - b. Remove the solar blanket and Solar Reel assembly from the pool completely before swimming use.
 - c. Do not store the solar blanket on the ground in direct sunlight, as it will burn the lawn
3. **Preparation & Assembly:** Check inventory of all items and assemble as illustrated below. Read all instructions prior to assembly!

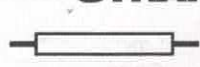

PARTS LIST

- (2) Molded Reel Stands
- (2) Crank Handles #54010
- (2) Roller Hubs #54020
- (2) Support Brackets #54030

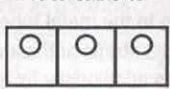
STRAP KIT

				
10 Cover Clips/ Nuts & Bolts	4 Rollers/Axels	12 x 1" Phillips	9 x 1.5" Hex Head	2 x 1.2" Crank Screw
	2 Sets Stand Brackets (4) Pieces #54040			
			5 Straps (4' 4")	

4. Depending upon the size of your pool you will also require one of the following tube kits:
(Tube Kit Assembly is detailed later)

Part #54000 3" Tube Kit
Fits pools 16'-21' in width

- (2) 94.75" x 3.0625" Diameter extruded metal shaft
- (1) 94.75" x 3.1875" Diameter extruded metal shaft
- (4) Through Bolts (1) Drill Bit
- (2) 24" Storage Straps
- (2) Wood Screw Storage Hooks

Part #54024 3" Tube Kit
Fits pools to 24' in width

- (2) 105.75" x 3.0625" Diameter extruded metal shaft
- (1) 105.75" x 3.1875" Diameter extruded metal shaft
- (4) Through Bolts (1) Drill Bit
- (2) 24" Storage Straps
- (2) Wood Screw Storage Hooks

5. **Positioning Your Solar Reel:**

For Rectangular pools, place top-rail brackets at either end of pool. Secure each bracket with 6 SS screws supplied.
For Oval pools, place top-rail brackets at either end of pool where radius begins. Secure each bracket as above.
For Round pools, place top-rail brackets at center of pool. Secure each bracket as above. **See Figure A next page.**

Fig. A

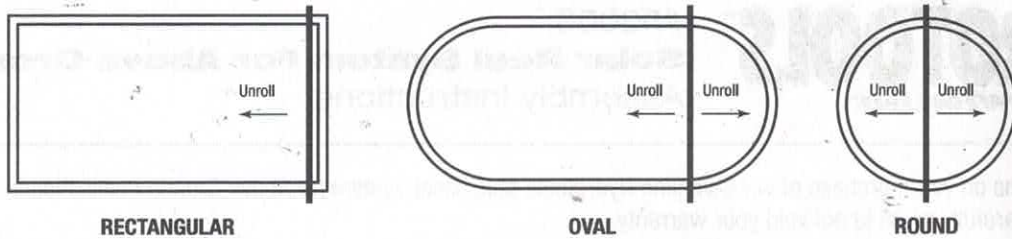

6. Trimming Your Solar Blanket:

- Lay your Solar Blanket (not provided) on top of water, bubble side down. **IMPORTANT!** Oval & Round Pool owners will need to fold their solar covers at point of placement of Reel Stands! The cover will unroll left and right of brackets & cross pole. Please allow 6 inches more material on length to allow for a fold where straps will be attached for wind onto reel system. (See Fig A above and Fig D below) With scissors trim blanket to fit shape of pool. Be sure to clear the inside top rail of pool.

7. ASSEMBLING The Reel System & Tube Kit :

- Insert 2 small Rollers & Axels into the recepticals in each of the 2 Support Brackets.
- Place Solar Blanket Reel Stand & Support Brackets at either side of the pool.
- Assemble (2) Crank handles to (2) Roller Hubs using (2) Bolts supplied. (Internal Gear Teeth face inward to drive Tube Poles) and place into Reel Stand as shown below.
- Loosely assemble extruded tubes together. Slide excess width into adjoining tubes, dividing it up as equally as possible. Note: You must have a minimum of 9" of overlap in each tube!
- Measure the width across the pool from back of roller hub to back of roller hub & adjust length of the tube assembly to fit the span.
- **With tubes on flat surface**, to ensure that poles are straight, secure each tube with 1-1"x1.5" hex head screw in each adjoining tube.
- **Slide tubes into hubs & secure with one 1.5" screw for each hub. When fit and span is correct, secure the Reel Stands to the pool top rail using the stand brackets and 3 x 1" screws per each 2 piece bracket assembly.**

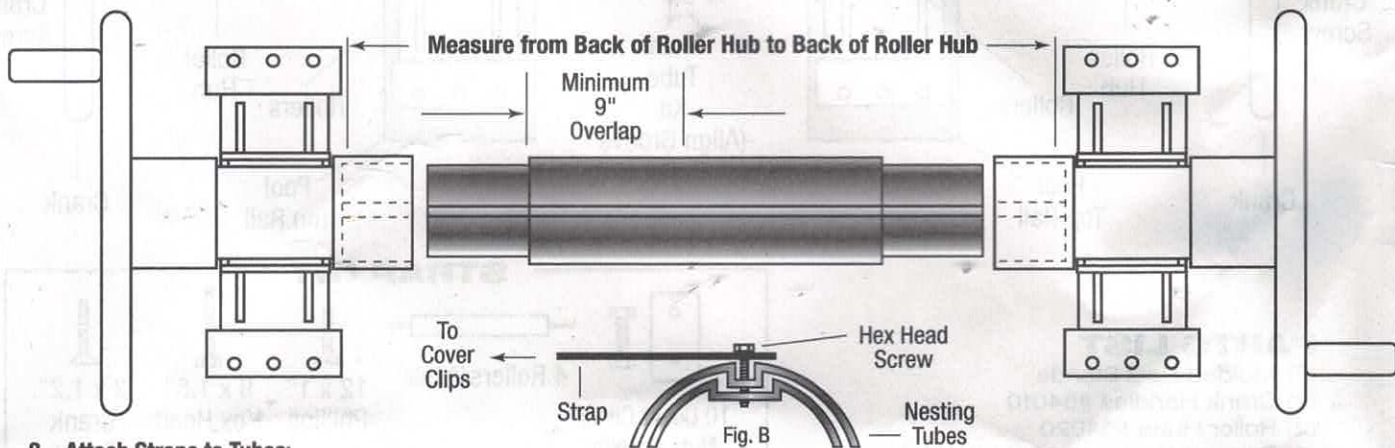

8. Attach Straps to Tubes:

Come in 6 inches from each tube end and attach a strap to the metal tube assembly. Use the hex head screws in the tube notch to attach the strap. Take the remaining 3 straps and connect them evenly along the length of the tube assembly. Use remaining hex head screws to additionally fix tubes together, spacing evenly. (See Figure B Above)

9. Attach Solar Blanket to Straps:

If Reel is to be placed at the end of the pool, attach cover to cover clips with plastic screws as shown in Figure C Below Left. If Reel is to be placed in offset position, then attach cover to strap plate forming a fold to act like a hinge and the plastic screws will go through two layers of the solar blanket as shown in Figure D Below Right. Bubbles should face down.

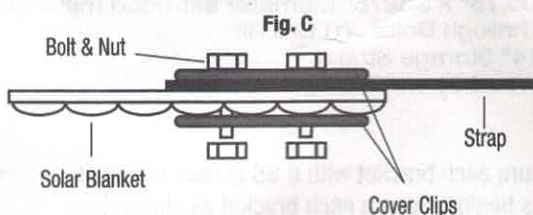

Fig. D

