

INSTALLATION INSTRUCTIONS AND RECOMMENDATIONS FOR USE



(to be read carefully and kept for future reference)

EVERYBODY INTO PISTOCHE!	3
I.1 - GENERAL DESCRIPTION OF THE PRODUCT	3
I.2 - PISTOCHE TECHNICAL DATA	3
SAFETY	4
PREPARATION	5
II.1 - PISTOCHE PACKAGING AND STORAGE	5
II.2 - PISTOCHE LIST OF PARTS	6
II.3 - INFORMATION PRIOR TO ASSEMBLY	8
II.4 - CHOOSING THE INSTALLATION SITE	9
II.5 - PREPARATION OF THE SITE IF PISTOCHE IS TO BE INSTALLED ON UNDEVELOPED GROUND	9
ASSEMBLY	10
III-1 - BUILDING THE PISTOCHE STRUCTURE	10
III-2 - ASSEMBLY OF THE PISTOCHE ROLLER	17
III-3 - ASSEMBLING THE COPING	19
III-4 - FITTING THE LINER	21
III-5 - MANIPULATING THE COVER AND COPING	22
III-6 - ASSEMBLING THE FILTER	24
FILTRATION AND WATER TREATMENT	26
EQUIPMENT MAINTENANCE	27
V-1 - CLEANING AND REPLACING THE FILTER CARTRIDGE	27
VIII.2 - CLEANING THE COVER	27
VIII.3 - WOOD TREATMENT	27
VIII.4 - LINER MAINTENANCE	27
VIII.5 - WINTERIZING	28
MAINTENANCE	29
IX.1 - HOW TO RESET THE ROLLER SPRING	29
IX.2 - REPLACING THE PUMP MOTOR	29
GUARANTEES	30
X.1 - LINER : 2 YEARS	30
X.2 - WOODEN STRUCTURE: 2 YEARS	30
X.3 - COVER: 2 YEARS FOR THE FABRIC; 1 YEAR FOR THE ROLLER	30
X.4 - FILTRATION GROUP: 1 YEAR	31
XI.5 - UNDERLAY	31

Watch the video to make assembly even easier!



Scan the code or come and visit us at Pistoche.fr

✓

EVERYBODY INTO PISTOCHE!

I.1 - GENERAL DESCRIPTION

Pistoche is designed for private use only, and more specifically, for young children to swim and splash around.

The pool is comprised of a wooden structure, waterproofed by a plasticised PVC liner, 0.5mm thick.

It is fitted with a cover made of reinforced PVC coated material, 450 g/m², mounted on an automatic self-winding roller integrated into the structure. When deployed, the cover is fastened in position on all four sides, by the roller abutment on one side and by a clever system of locking grips located under the hinged coping on the other three sides.

The cover performs the following functions:

- Secures the pool while it is not in use (Nota Bene: this cover does not comply with the French safety standard NF P 90-308, which is specific to in-ground, or partially in-ground, private family pools and does not concern paddling pools).
- Keeps water clean (vegetation, insects, etc.)
- Limits loss of water via evaporation
- Inhibits the growth of algae (effect of opacity)

It is also equipped with a space saving filtration system that sits into a corner of the pool. The height of the filtration system can be adjusted to a water depth between 40 cm and 58 cm.

Pistoche pools are not intended to be dismantled after the pool season. Nevertheless, given its small size and light weight when empty, it can be lifted easily by 2 adults and moved into storage in a shed or a garage.

The wooden structure is made of Northern red pine and spruce from sustainably managed forests, the wood supply chain is PEFC certified.

The wooden parts are core treated against rot:

The vertical wall slats are 28 mm thick and are class III treated.

The bottom planks (slats in contact with ground) as well as the copings are class IV treated for better protection against humidity given their position.

However, despite this treatment, the wooden structure should not be sunk into the ground, even partially. It must be placed on the ground. Failure to respect this instruction will cancel the guarantee against wood rot.

Lastly, wood is a natural, noble but "living" material. Imperfections (knots, seams, cracks etc.) and the effects of time on its living structure (resin beading, colour changes, greying, slight deformations, etc.) cannot be avoided.

I.2 - PISTOCHE TECHNICAL DATA

Foot print: 2.3 m x 2.3 m

Overall height: 0.67 m

Water volume for a water depth of 58 cm: 2320 litres

Total weight with a water depth of 58 cm: 2270 kg

Integrated pump and cartridge filter: flow rate 2 m³/h, powered by a 230 V / 12 V AC power supply to the filtration system by a 5 m cable.



SAFETY

IMPORTANT



Never allow your children into the pool without the active surveillance of a responsible adult

Do not allow your children to jump or dive into the pool from the coping or from any other structure

Remove any toys from the pool while it is not in use (children could try to retrieve them while you are not watching)

Deploy the integrated cover over the pool while it is not in use

Never allow your children to use the cover as a trampoline or a sun lounger

Never close the cover while a child is in the pool

If pool chemicals are being used to treat the water:

- follow the manufacturer's instructions very carefully;
- never add chemicals to the water while the pool is in use;
- make sure that the pool chemicals (solids) are totally dissolved, and run filtration for at least one hour before allowing children into the pool to ensure that the chemicals are completely mixed into the water;
- store chemicals out of the reach of children, preferably under lock.

If you want to add an additional means of access to your Pistoche pool (steps, ladder), choose one that can be "locked" (to prevent access while the pool is not in use), failing this move the means of access away from the pool.

Only use the original filtration system, never try to adapt any other filtration system to your Pistoche pool. This could create a risk of entrapment of bathers due to the pump's suction force.

Do not allow your children to climb on, or sit on, the filter.

Electrical hazards:

- The filter power supply must be more than 3.5 m from the pool
- check the power cable and the cable between the filter and the power supply regularly for damage, and replace them immediately if they are damaged (cut, pinched, worn, etc.)
- never submerge the filter in water
- never bring a device powered by a voltage greater than 12 V closer than 3.5 m to the pool. For installations outside France, refer to the regulations in effect in the country of installation.

Educate your children about the dangers of disregarding safety rules.

PREPARATION

II.1 PISTOCHE PACKAGING AND STORAGE

Package no.1 (box) :

Dimensions: 0.4 m x 0.4 m x 0.6 m

Weight: 10 Kg

Contents:

- Liner
- Filter
- Screws and bolts
- Fastening components
- Installation instructions



Package no. 2 (pallet) :

Dimensions: 2.30 m x 0.61 m x 0.45 m

Weight: 150 kg

Contents:

- Wooden structure
- Cover pre-mounted on its roller
- Liner locking track profiles
- Underlay



The wooden parts are strapped together. Do not undo the straps until you are ready to build the structure. Before assembly, the wood package must be stored sheltered from the rain and sun.

Before beginning assembly, check that all the Pistoche pool components are present.

Once assembly has begun, it should be completed as quickly as possible to avoid any deformation of the parts.



II.2 - PISTOCHE - LIST OF PARTS

PACKAGE 1/2

FILTRATION

101	Lost head nails 2x35	Qt :
		24

102	Countersunk screws 5x60	Qt :
		95

103	Countersunk screws 4x35	Qt :
		8

104	Countersunk screws 4x20	Qt :
		24

105	Round head screws 4x20	Qt :
		95

106	Torx screws 6x25	Qt :
		16

214	Hung PVC 150 mm	Qt :
		6

219	Support bracket	Qt :
		2

220	Reinforcing plate	Qt :
		4

300	Filter base	Qt :
		1

301	Filter pump	Qt :
		1

302	Filter body	Qt :
		1

303	Filter cartridge	Qt :
		1

304	Filter support guide	Qt :
		1

305	Adjustable filter lid	Qt :
		1

306	Skimmer lid	Qt :
		1

307	Skimmer guide	Qt :
		1

308	Skimmer grate	Qt :
		1

309	Suction cup	Qt :
		2

310	Polystyrene wedge	Qt :
		4

400	Roller flange	Qt :
		2

401	Tensioning hook	Qt :
		2

402	Centering shoe	Qt :
		8

403	Cover pit bracket	Qt :
		2

404	Safety stop	Qt :
		6

500	Liner	Qt :
		1

501	Locking angle	Qt :
		4



PACKAGE 2/2

200	Wall slat 2203x68x28 mm female	Qt : 2	201	Wall slat 2203x77x28 mm male	Qt : 2
202	Wall slat 2130x145x28 mm female	Qt : 2	203	Wall slat 2203x145x28 mm	Qt : 14
204	Bottom plank, class IV pine 2204x132x28 mm	Qt : 4	205	Pine coping support edging 2076x86x28 mm	Qt : 3
206	Roller pit plank 2203x127x28 mm	Qt : 1	207	Roller pit bottom plank 2187x74x28 mm	Qt : 1
208	Vertical pine reinforcement 634x86x58 mm	Qt : 6	209	Vertical pine reinforcement 535x86x58 mm	Qt : 2
210	Finishing strip 584x17x44 mm	Qt : 6	211	Finishing strip 485x17x44 mm	Qt : 2
212	Class IV pine coping 2099x145x28 mm	Qt : 4	213	Hung PVC 1688 mm	Qt : 3
215	Hung PVC cover pit exterior 1988 mm	Qt : 1	216	Hung PVC cover pit interior 1988 mm	Qt : 1
217	Aluminium strip 1980 mm	Qt : 4	218	Underlay	Qt : 1
405	Roller with cover	Qt : 1			

II.3 - INFORMATION PRIOR TO ASSEMBLY

Number of people required for assembly: 2 people

Time required by 2 people: 4 hours



Tools needed to build the structure and accessories:

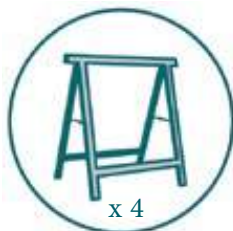

Rubber or wooden mallet



Metal drill 4mm
Wood drill 4 mm



Torx heads
T-20 - T-25 - T-30



Tools required to prepare the ground if the pool will be installed on natural ground:

- Rake, spade, wheel barrow, spirit level, compaction roller
- Consumables that may be required: sand

Nota bene: The day before installation, the liner should be stored at between 15 and 25°C so that it is pliant enough but not too pliable. Only bring it outside when you are ready to fit it.

Explanation of the pictograms that feature in this document:



Operations to be performed on the roller pit side.



Operations to be performed on the side opposite the roller pit and on the sides adjacent to the roller

II.4 - CHOOSING THE INSTALLATION SITE

The installation site should be selected with regard to the following:

- Pistoche should be living areas in the home;
- if Pistoche is installed on natural ground, make sure that the site is not infested by termites or other wood eating insects;
- to avoid premature degradation of the bottom of the wooden structure, rain water should not be able to accumulate and stagnate around Pistoche (if water is likely to stagnate around the pool, create a drainage system);
- to prevent falls, the area around the pool should not be slippery when wet (bad weather, splashing);

The ground underneath Pistoche must be perfectly:

Flat, stable, and should remain so over time (no subsidence or deformation);

Perfectly horizontal, so that water pressure is not higher in some areas of the structure than others;

Failure to follow these instructions may cause the cover locking system to malfunction.

- If Pistoche is installed on a balcony, a raised terrace, or some other support that does not bear down on the ground through the whole of it's surface area, check that the structure will bear the total weight of Pistoche, water and the users.

II.5 - PREPARATION OF THE SITE IF PISTOCHE IS TO BE INSTALLED ON NATURAL GROUND

Trace the outline of Pistoche on the ground;

Level and smooth the surface, remove any protruding objects (stones, roots, stumps, etc.);

Compensate for any soil removed during the previous step by adding sand, or gravel topped with a layer of compacted, levelled sand 5 mm thick.



ASSEMBLY

III-1 - BUILDING THE PISTOCHE STRUCTURE

201	×2
203	×2
204	×4

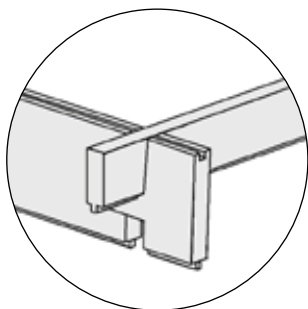

102	×12
-----	-----

Make sure that the four corners are square.
Use 12 countersunk screws, 5x60, to assemble the base.

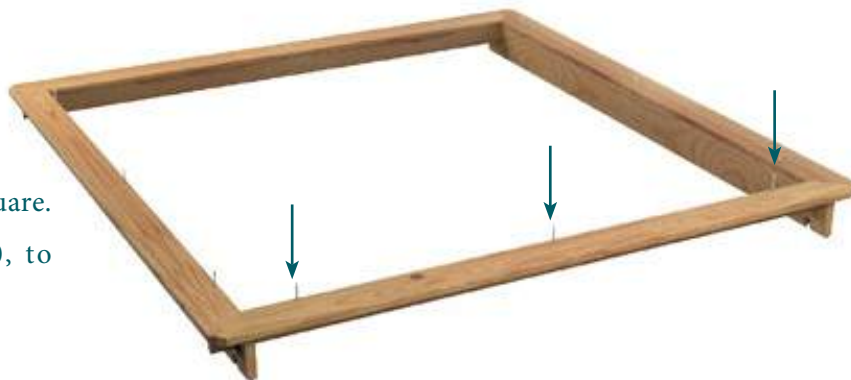

220	×4
106	×16

Screw a metallic reinforcing plate onto each of the four corners.





208	×6
209	×2
102	×16

Check that the bottom planks (204) and vertical reinforcements (208 and 209) are square, then screw them together.



IMPORTANT: Two of the braces are shorter than the others and should both be positioned on one of the sides that has a full vertical slat (203). The cover pit will be located on this side.

The reinforcements have a specific orientation:

Interior
of the
pool



Exterior
of the
pool

*Side opposite
or adjacent to
the cover pit*

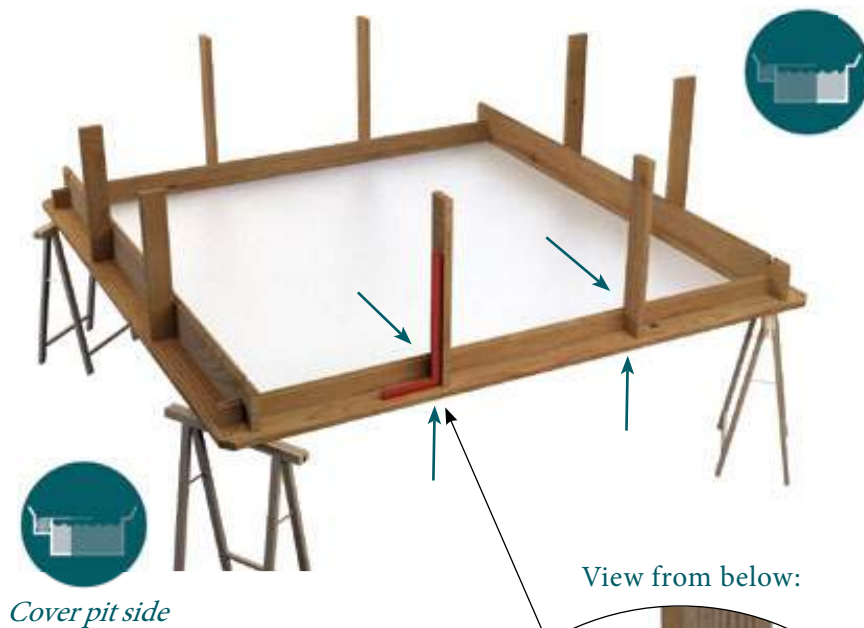

203 ×4



203 ×8
202 ×2



200 ×2



Once all the slats have been assembled, make sure that they are correctly interlocked.



Make sure that the vertical reinforcement are square (208 and 209) with respect to the bottom planks (204).



102 ×20

On the cover pit side, screw the 2 bottom slats into position. On the other three sides, fasten the bottom 3 slats into position.

Make sure that the screws are inserted deep enough to avoid damage to the liner afterwards.

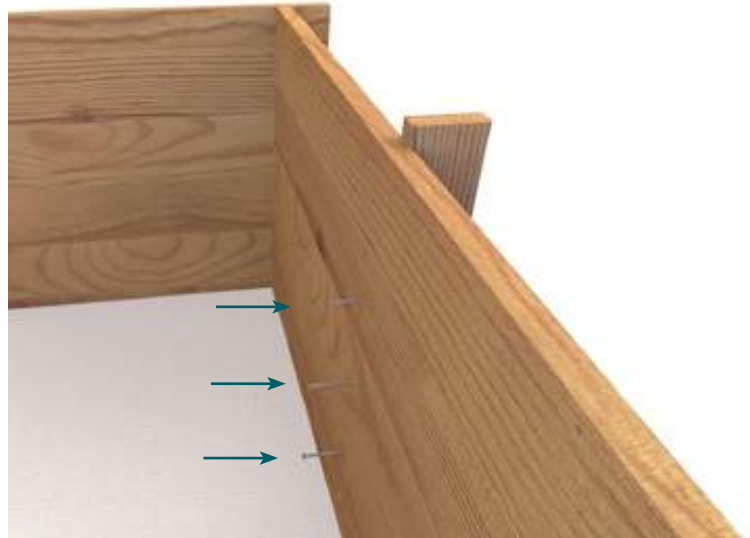



Measure the height H on each of the 4 sides of Pistoche.

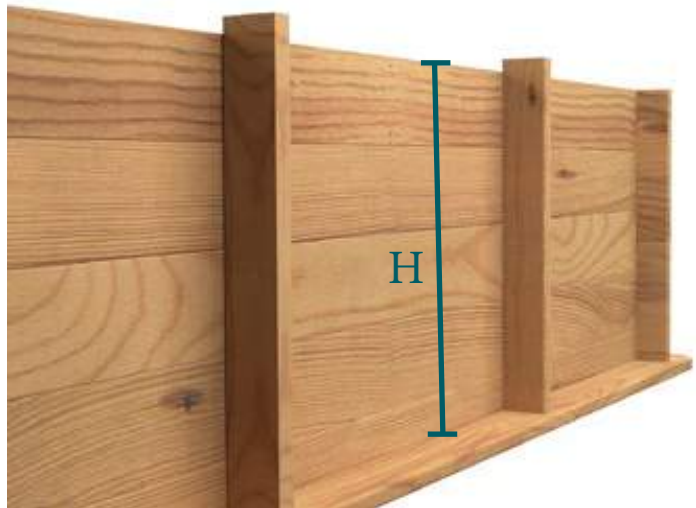

208 ×6

Trim the 6 taller reinforcing braces (634x86x58 mm):

Remove the top slat (203).



Mark the height H minus 2.8 cm around the circumference of each of the 6 reinforcing braces.

Given that wood is a living material, H may vary slightly.

Trim the 6 reinforcing braces.

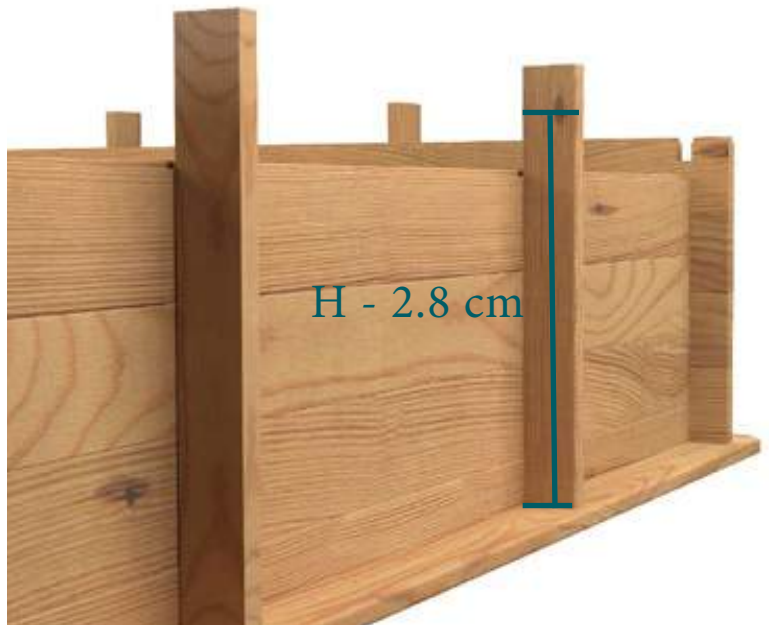

209 ×2

Trim the 2 short braces (535x86x58 mm) :

Remove the top half-slat (200) and the first full slat (203).



Mark the height H minus 12.7 cm around the circumference of each of the 2 shorter reinforcing braces.





102 x12

Once the slats have been reassembled, make sure that they correctly interlocked before screwing the top slats into position.



205 x3

102 x15

Make sure that coping support edging is flush with the upper surface of the top slat:



Attach the vertical slats and vertical reinforcements to the coping support edging using 5 screws (102):

- The three holes used to attach the slat (203) to the coping support edging (205) are pre-drilled.
- Pre-drill the coping support edging (205) before inserting the two vertical screws.





207 ×1
102 ×7

The three holes used to attach the slat (203) to the bottom plank of the roller pit (207) are pre-drilled.

Pre-drill the bottom plank of the roller pit (207) before inserting the four vertical screws.

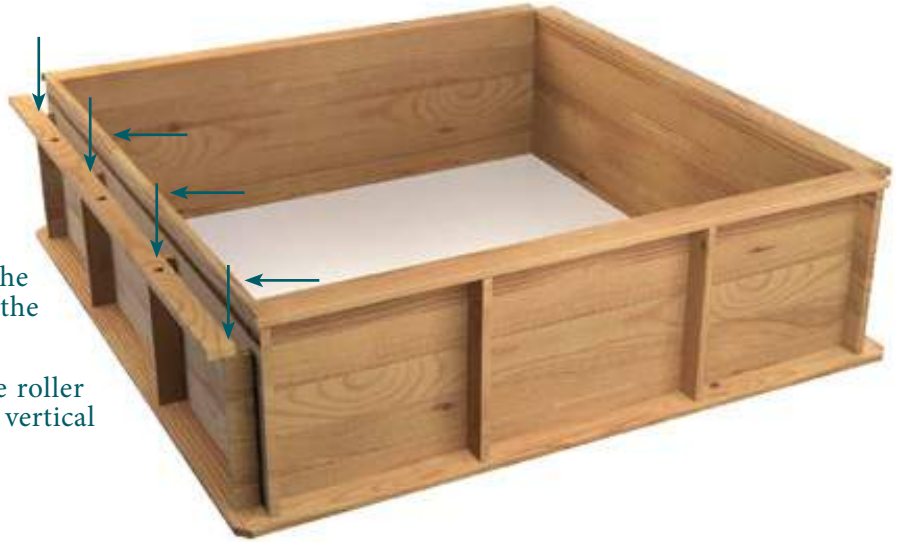

102 ×4

Block the structure together using 4 screws (102).

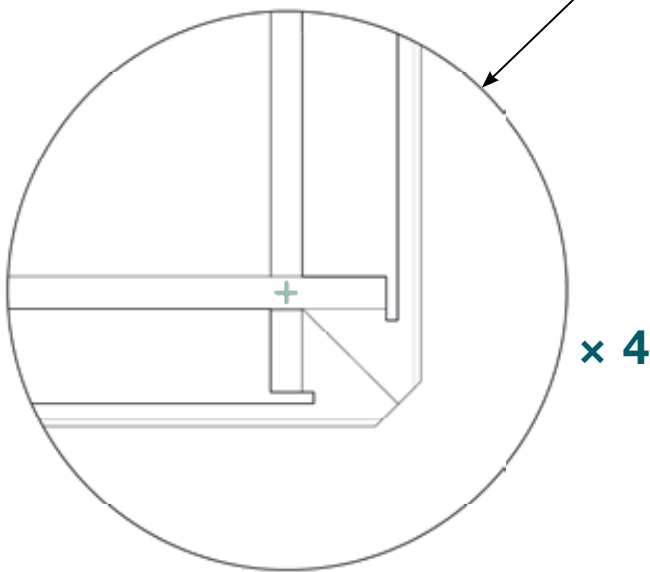
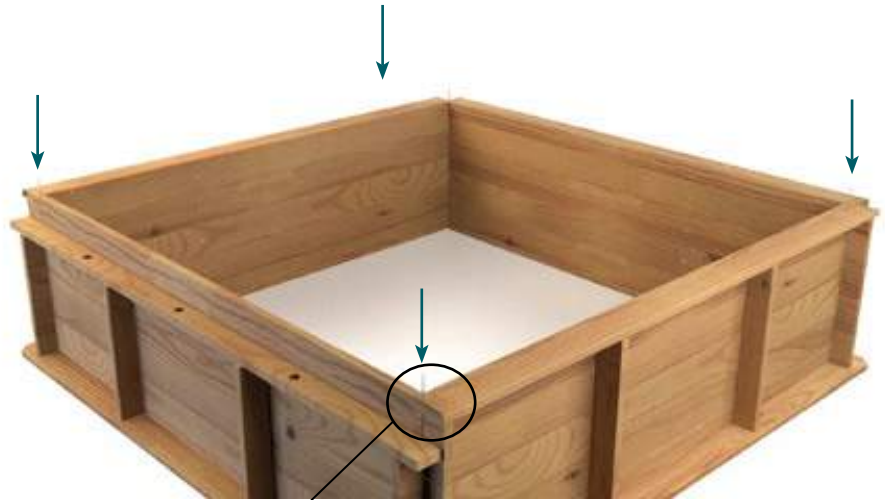

III-2 - ASSEMBLING THE PISTOCHE ROLLER



403	×2
104	×8



400	×1
103	×3

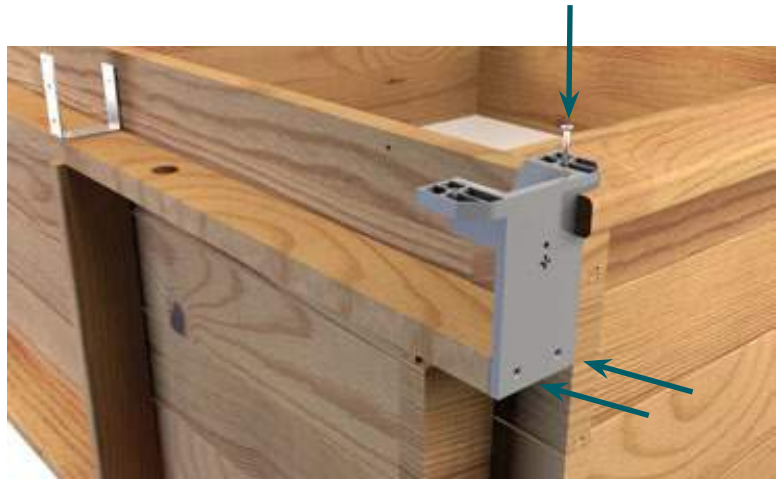

405	×1
-----	----



400	×1
103	×3





Fasten the brackets (403) to the rear roller pit plank by inserting screws (104) from the outside of the roller pit.

206	×1
102	×4
103	×2
104	×2



Nail on the finishing strips .

210	×6
211	×2
101	×24



Position the 6 15 cm hung locking track pieces:

214	×6
105	×18

- against the vertical pool slat (see diagram 1)
- 6 mm from the perpendicular wall (see diagram 2)

diagram 1

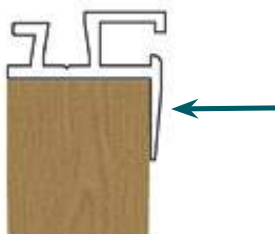

diagram 2



213	×3
105	×12

Position the 3 168.8 cm hung locking track pieces:

- against the vertical pool slat (see diagram 1)
- between the 15 cm hung locking track pieces mounted during the previous step



215	×1
216	×1
105	×8

On the roller pit side, centre the inside and outside hung locking track pieces positioning them 107 mm from the roller flanges (400).

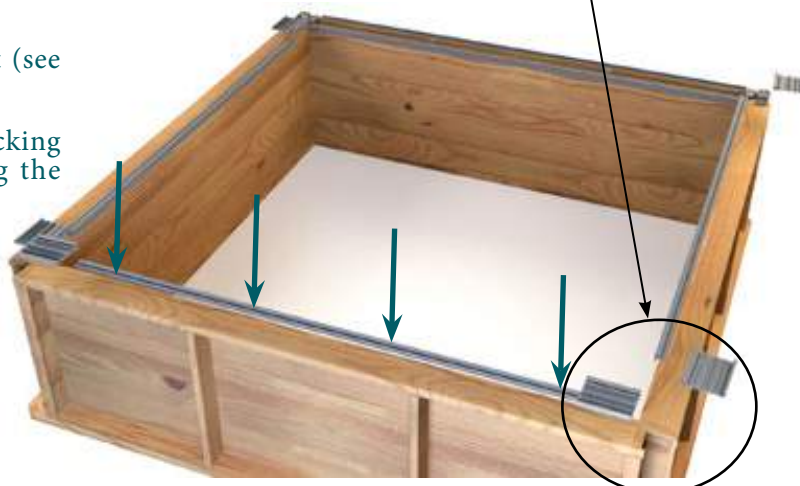

III-3 - ASSEMBLING THE COPING



Coping - roller pit side:

212	×1
217	×1
219	×2
105	×14

Drill the aluminium strip (217) according to the diagram below.



Centre the strip on the coping (212) positioning the hinged section along the longer side of the coping.

Toward the outside of the pool (long side)

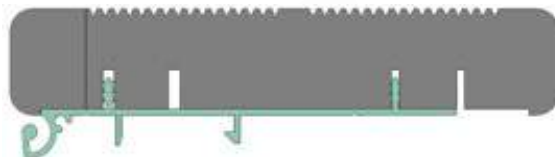

Position a support bracket (219) at both ends.



Coping - sides adjacent to and opposite the roller pit:



The aluminium strips (217) installed on these three copings (212) should be centered, positioning the section opposite the hinge along the short coping length.

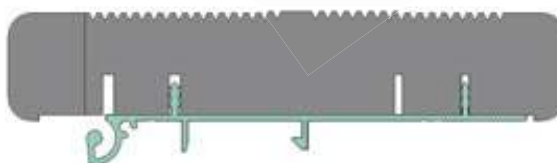

Toward the inside of the pool (short side)

212	×1
217	×1
105	×8

Coping - side opposite the roller pit: Drill the aluminium strip (217) according to the diagram below.



212	×2
217	×2
105	×16

Coping - adjacent to the roller pit: Drill the aluminium strip (217) according to the diagram below.

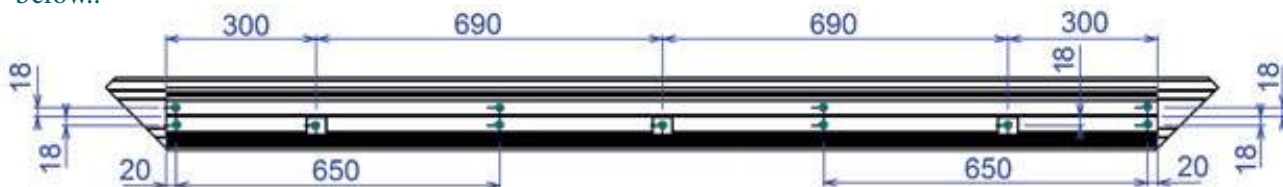

404	×6
104	×6

Mount the safety stops on both of these copings



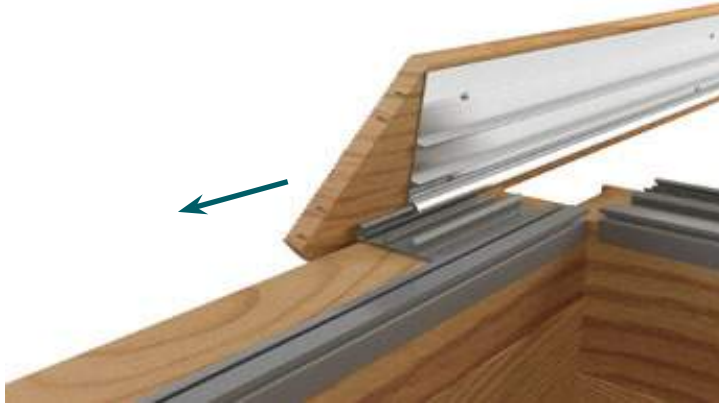

402	×8
105	×8

Centre the coping on the coping support edging.

Insert a screw into the slot on each stop to prevent the coping from sliding from side to side.

Close the coping to check their position. If necessary, loosen the screws in the stop slots and slide the stops to adjust their position.

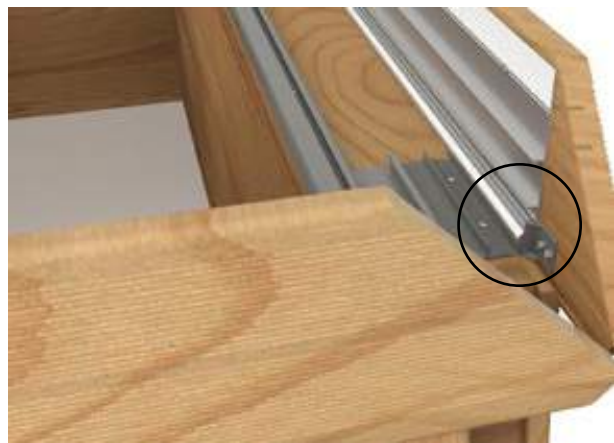

Remove the pin to free the roller.

Keep it in case you need to reblock the roller in the future.

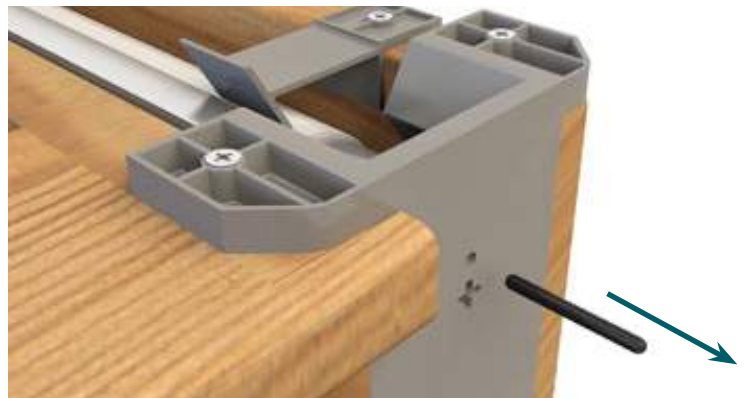

III-4 - FITTING THE LINER



IMPORTANT: The surface underneath the underlay should be clean and free of any roughness or foreign bodies, even tiny bumps will be visible because of the pressure that water exerts on the liner.

218 ×1
500 ×1

Clean out the pool, then lay the liner inside the pool and unfold it, taking care to ensure that it lines up with the corners. Smooth out any creases.

The liner's vertical weld should be positioned in a corner opposite the cover pit and should be hidden by the filtration system for aesthetic reasons: start attaching the liner at this corner.

Translucent beading is welded to the top of the liner.

Push the translucent beading fully into the groove of the PVC hung liner locking track (213 and 216) and proceed like this around the entire periphery of the pool taking care to exert the right amount of tension on the liner.



IMPORTANT: Do not slide the liner along the locking track to reposition it, this could tear the liner. Pull it out of the track and reinsert it in the correct position.

Flatten the liner against the floor of the pool and push it into the horizontal and vertical corners to smooth out creases as much as possible. Do not fill the pool while creases remain.

500 ×1



Fill the pool with water to a depth of between 40 cm and 58 cm.

While the pool is filling, assemble the filter (page 24).



III-5 - MANIPULATING THE COVER AND THE COPING

Close the cover, then engage the tensioning bar along its entire length as shown in the diagrams below:

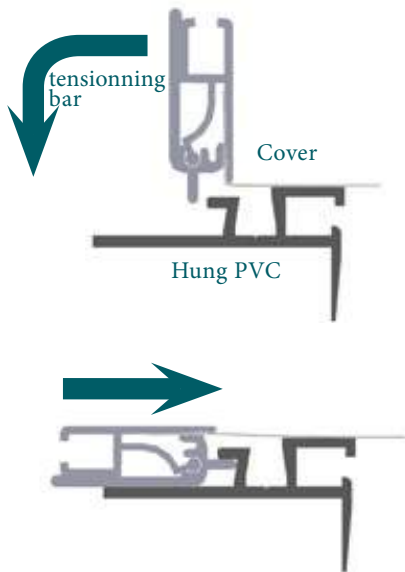

401	×2
104	×2

For each of the two hooks:

- Insert the tongue of the hook into the hole provided for that purpose in the cover;
- exert tension on the cover by pulling on the hook until the edge of the cover is taut;
- fasten the hook in this position.

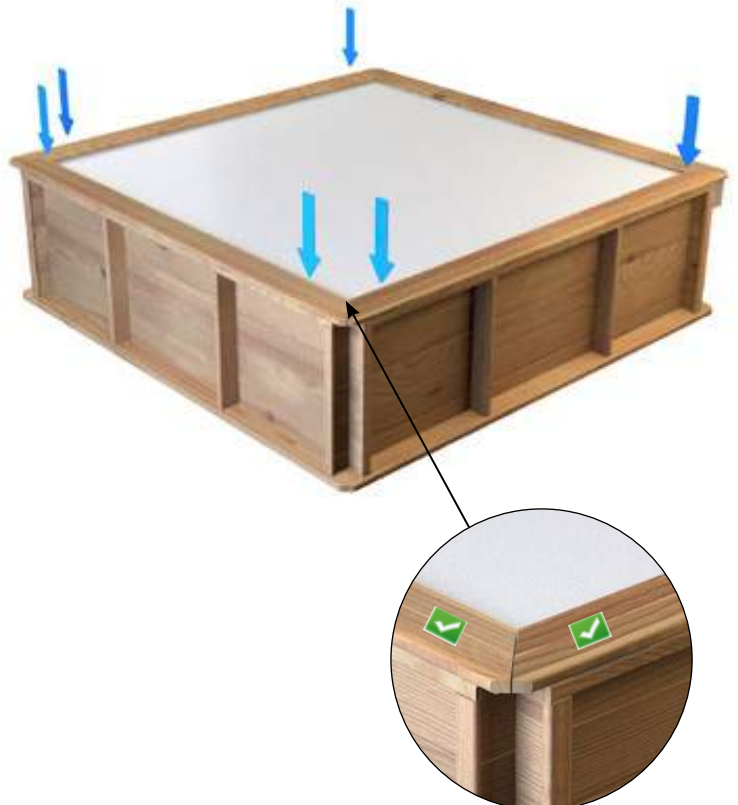

Closing the coping

- Lay the cover strap along the tensioning bar.
- Close down the coping on the cover pit side first.
- Then close down and lock the 3 other copings.
- To do this, push down on both ends with the flat of you hand until you hear a click.
- Pull the coping upwards to check that it is locked in position.

OPENING THE COPING

To open the coping, push it towards the inside of the pool with your leg, and while maintaining this pressure, pull the coping up.



Rolling the cover up

Open the coping on the cover pit side last.

Swivel the tensioning bar to open the cover.

Accompany the cover as it is rolling up such that it does not come in contact with the water.

If the oblong holes in the side of the cover are not aligned with the PVC hung locking track (213), check that the walls of the Pistoche pool are perpendicular to each other.



Important: never completely release the cover to roll it up, this could tear the cover.



If the cover does not roll up completely, unroll the cover and roll it up again.

If this problem persists, check that the water is not more than 58 cm deep.

III-6 - ASSEMBLING THE FILTER

- 301 ×1
- 302 ×1

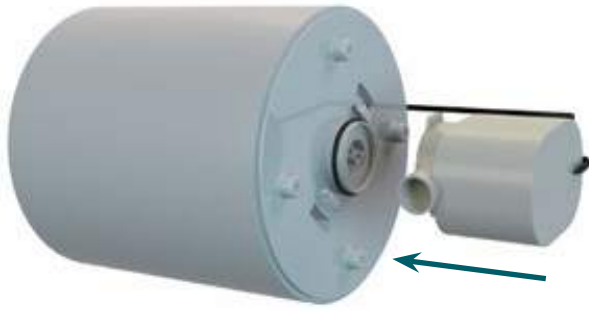

- 300 ×1
- 105 ×4



- 303 ×1

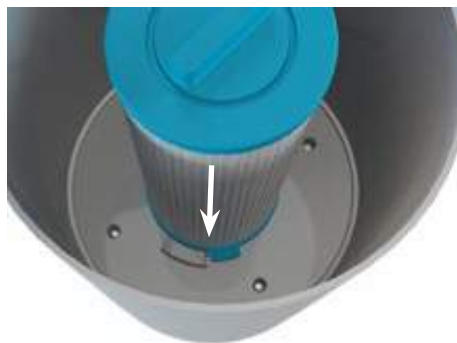

304 ×1
105 ×2

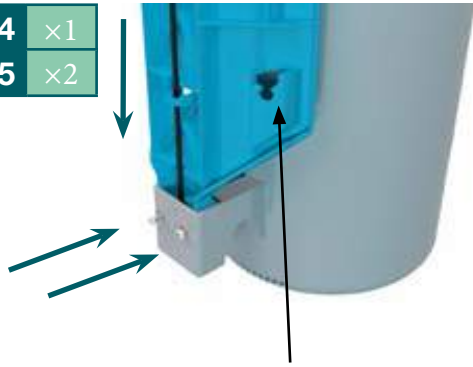

Insert the suction cups into the 2 openings on the bottom of the support guide.

305 ×1
307 ×1



306 ×1
308 ×1
309 ×4



Clip the grate (308) onto the skimmer lid (306).

Position the 4 polystyrene blocks (309) under the lid (306)



Depress the tongue to release the filter and adjust its height. Three positions are possible corresponding to three water depths:



water depth 40 cm



water depth 50 cm



water depth 58 cm

FILTRATION AND WATER TREATMENT

Once your pool has been filled with water, the water will tend to become dirty and the water quality will deteriorate because of pollution introduced by bathers (bodily secretions, but also twigs, grass, earth, sand, etc. stuck to their feet or their skin), as well as contaminants deposited by the wind (leaves, petals, pollen), and insects.

Filtration slows the natural deterioration of water by trapping tiny solid contaminant particles (from a few millimetres down to tens of microns).

The length of time that filtration should be run each day will mainly depend on the level of water pollution, and on the water temperature. As a guideline, during periods of daily use, the following minimum filtration times are recommended:

Water temperature	Minimum filtration run time
20°C	5 hours/ day
25°C	8 hours/ day
30°C	12 hours/ day

These recommendations have been established for the original filtration system that comes with your Pistoche pool; for safety reasons we strongly advise against adapting any other filtration system to your Pistoche pool.

IMPORTANT: the cartridge equipping the filter is not compatible with the use of flocculants (liquid chemicals formulated to remove the tiny particles suspended in the water that would not otherwise be trapped by the filter).

However, filtration alone will not completely eliminate the health risks posed by the growth of bacteria, fungi, etc. To keep water clean for as long as possible and reduce the frequency of water renewal, the water will need to be treated with chemicals.

The Pistoche pool chemical kit (available as an option) comprises:

- A disinfectant that destroys bacteria and viruses (pouch of liquid chlorine);
- a chemical that impedes the development and growth of algae (Hydrogen Peroxide);
- a floating sponge that captures oily materials floating on the surface (Water Lily).

Refer to the instruction booklet enclosed with the kit for information concerning the dosing frequency, and quantities, for each chemical to be added. Take care to respect these. We will not accept responsibility for damage caused by using other pool chemicals without the advice of a pool water treatment specialist.



EQUIPMENT MAINTENANCE

V-1 - CLEANING AND REPLACING THE FILTER CARTRIDGE

Check the condition of the filtration cartridge regularly (at least once a week while Pistoche is in use) if necessary clean it as follows:

- 1) Stop filtration by disconnecting the electrical supply;
- 2) Remove the lid to access the cartridge;
- 3) Remove any large objects by hand before removing the cartridge;

4) Clean the cartridge using a jet of water and a soft brush between the folds;

5) Reassemble the filter by carrying out the operations in the reverse order.

If the cartridge remain dirty despite cleaning, replace the cartridge with a new, identical cartridge. Do not try to adapt a different cartridge to the filter.

VIII.2 - CLEANING THE COVER

Clean the cover with a water jet and soap or a liquid detergent, and a soft brush. Do not use solvents or abrasive products.

IMPORTANT: The cover features small holes that allow rain water to drain through so that it does not accumulate on the cover. Make sure that they do not become blocked by debris.

VIII.3 - WOOD MAINTENANCE

To preserve the wood's initial colour, simply apply a colourless stain at regular intervals.

You may alternatively use a colour stain, or colourless oil to nourish the wood and slow discolouration.

Before applying the treatment, make sure that it is

micro-porous and will allow all the wood to breathe.

Do not apply the product on areas in contact with the wood, it could migrate through the liner and stain it.

Also, for the same reason, take care not to apply too much product at the slat joins.

VIII.4 - LINER MAINTENANCE

Given that the liner is exposed to sunlight and water disinfection oxidising products, slow and gradual discolouration is inevitable.

This phenomenon will be accelerated and exacerbated if the water pH is too low (less than 6.8 for chlorine), or if excessive quantities of disinfectants are used.

If conditions are really extreme, creases could appear in the liner and it will lose its elasticity.

On the other hand, if the pH is too high (pH > 7.8 for chlorine), the disinfectant power of the oxidising products will be severely reduced, or even lost, thus allowing the growth of micro-organisms.

Therefore, it is important to:

- measure the water's pH regularly, and keep it between 7 and 7.5;
- take care not to overdose the pool with disinfectant products.

Specifically, do not allow solid disinfectants (tablets, pellets) come into contact with the pool floor: on contact, they will discolour the liner, leading to the formation of a white stain, and creases will appear at the interface.

At the water line, the liner is vulnerable to deposition of various pollutants floating on the surface of the water (sun cream residues, exhaust fumes, wood smoke, etc.). The Water Lily sponge will absorb most of the oily substances floating on the water surface, however the water line should be cleaned

using products compatible with PVC-P liners as soon as a brown line starts to appear. Over time, these deposits could become encrusted in the material making them impossible to clean off.

Dead leaves, twigs and insects that sink to the bottom of the pool should be removed by vacuuming or using a leaf rake. Otherwise, their decomposition could lead to staining of the liner.

VIII.5 - WINTERIZING

If the pool will left outdoors over winter:

- Empty all water out of the pool;
- Drain the filter and store it and the power supply somewhere dry;

Prevent the expansion of ice pushing on the structure:

- Take 5, empty, 1.5 litre plastic bottle;
- Weight them with a little gravel or sand and cap them tightly;
- Tie them together with string to create a chain of bottles;
- Tie each end bottle to a stone using a string about 90 cm long;
- Place the stones on the pool floor centred at the base of two opposite walls.

If water gathers in the pool, the empty bottles will float. If temperatures drop below zero and ice forms on the surface, the bottles will absorb the expansion of ice instead of the pool structure.

Roll the cover out over the pool.

IMPORTANT :

Check regularly that the water drainage holes are not blocked: clear away any debris that falls onto the cover.

If it snows, open the cover. Otherwise the cover could be damaged by the weight of the snow that accumulates on it.

Check regularly that the depth of the water accumulating in the pool due to precipitation does not exceed 58 cm, drain if necessary.

If algae grows in the pool, treat the water with an algaecide to limit this phenomenon.

At the beginning of the following pool season, open the pool, drain any water that has accumulated and clean the liner carefully before refilling the pool.

MAINTENANCE

IX.1 - RESETTING THE ROLLER SPRING

If you need to dismantle the cover roller flanges, put the locking pin back in position before removing the cover roller to avoid releasing the roller spring.

If, despite this precaution, the spring is released, reset it as follows :

- 1) Dismantle the roller and the flange on the spring side (right hand flange if you are standing outside the pool and facing the roller);
- 2) Place the semicircular notch at the end of the

roller and the notch on the rotating axle opposite each other and fit them together to reform the hole that will hold the pin, push the pin into this hole;

- 3) Mount the flange on the roller, then remove the pin;
- 4) Rotate the flange through 20 full turns anti-clockwise, then replace the pin.
- 5) Replace the roller in its pit. Fix the flange to the wooden structure and remove the pin.

IX.2 - REPLACING THE PUMP MOTOR

Disconnect the power supply to the filter.

Unhook the filter, taking care not to damage the liner.

Remove the lid, and then the cartridge.

Unscrew the 4 screws at the bottom of the filter body.

Replace the pump and repeat this procedure in the reverse order.



GUARANTEES

The following guarantees are granted as of the purchase date, on presentation of the invoice or receipt:

X.1 - LINER: 2 YEARS

Leaktightness and resilience of welds, subject to the condition that instructions concerning fitting, water treatment, and liner maintenance were followed (see sections IX, XII and XIII.4)

The following phenomena, associated with improper operation or maintenance, are excluded from the scope of guarantee:

- Creases that appear after the liner is fitted, caused by slippage of the membrane on loose or sloped ground, or inappropriate water chemistry: water temperature must remain below 28°C, the pH must be between 7.2 and 7.6, and the concentration of the disinfecting agent must

remain within the range recommended by the manufacturer of the pool chemicals.

- Colouring or staining of the liner along the water line, due to inadequate cleaning (see section XIII.4)
- Stains, discolouration and creases of any type.
- Damage caused by contact of incompatible materials with the liner.
- Tears in the liner under the beading caused during fitting by moving the liner without first pulling it out of the locking track.

X.2 - WOODEN STRUCTURE: 2 YEARS

Rotting, attack by insects other than termites, subject to the condition that instructions set out in sections III, VI, VII and VIII were followed.

This guarantee does not cover natural deformations (splitting, cracking that does that impact the mechanical strength of the wood) or colour changes caused by weathering.

The following defects associated with incorrect assembly or storage are notably excluded: wall slat deformations (exposure to the sun, assembly deferred after opening the package), deformation or breaking of the slats due to assembly in any manner other than that described in the instructions. Rotting of the wood caused by use of an unsuitable, non microporous treatment is also excluded from the guarantee.

X.3 - COVER: 2 YEARS FOR THE FABRIC; 1 YEAR FOR THE ROLLER

This guarantee applies subject to the condition that the water treatment recommendations set out in section VIII, and the winterizing recommendations set out in section IX.5 were followed.

The following are excluded from the scope of this guarantee:

- Tearing of the fabric attributable to excessive tension on the cover, caused by snagging of the cover on an object or by a person falling onto the cover.

- Normal wear along the edges or at the fastening points.

To avoid the growth of mould on the cover during the time of year that the pool is not in use, make sure to clean and dry the cover before storing it.

X.4 - FILTRATION GROUP: 1 YEAR

The cartridge is considered a "wear part" and is not covered in the scope of this guarantee.

The motor is guaranteed, subject to the conditions that the pump was not allowed to run dry, and that the filter cartridge was cleaned in accordance with the instructions set out in section IX.1.

Plastic components are guaranteed subject to

the condition that they have not been exposed to incompatible chemicals, or concentrations of chemicals outside the ranges recommended for pool water, and that they have not been subject to impacts or abnormal stress or strain.

The transformer is covered by the guarantee subject to the condition that it was not sprayed with, or immersed in, water.

XI.5 – UNDERLAY

The underlay is not covered by any guarantee.

WOOD, A NATURAL MATERIAL.

Being a natural, living material, wood will have some imperfections. These are normal and have no impact on the service life of the product. A certain number are superficial and are not covered within the scope of the guarantee



>> Colour variations

Colour variations are common to every species of wood. Treatment brings them out because the depth of penetration of the product will depend on the wood density and grain. Weathering of wood outdoors will significantly attenuate these colour variations.



>> Greying

Wood exposed to sunlight is susceptible to greying. Some people like the silvery sheen of this natural patina. If, however, you would prefer the wood to keep its original colour with brown tones, apply a protective coating (lasure, oil) when the product is assembled.



>> Surface mould

Mould, caused by microscopic fungi, can grow on wood, particularly on resinous species, on which the growth can appear as «blueing». It is a surface phenomenon, exacerbated by heat, humidity and inadequate aeration and is characterised by stains ranging from light to dark blue. They can be removed by wiping the surface.

Remember that class IV treated wood is protected against attack by fungi that could destroy the physical and mechanical properties of the wood. For further information, please refer to Procopi's guarantees concerning the types of wood and their treatment.



>> Resin beading

When resinous wood species are autoclaved, the alternating pressure and vacuum can cause sticky resin residues to rise to the surface. To remove them, scrape them carefully with an appropriate tool, being careful not to touch the wood. Turpentine spirits could also be effective, but could stain the wood if too much is applied.



>> Splitting and cracking

Wood expands and contracts when exposed to variations in humidity and temperature. As it dries, wood contracts unevenly resulting in the appearance of cracks. While these can seem to be cause for concern, they have no impact on the mechanical properties of the product and therefore do not fall within the scope of the guarantee.



>> Salt stains

Small green stains are frequently found on the surface of autoclaved wood. These can be removed with light sanding. If left untreated, this colour will disappear over time.



>> Knots

Knots mark the places where branches were attached. The quantity and size depends on the species of wood and the sorting process. For outdoor installations, small adherent knots are acceptable. The more stringent the sorting process to limit the number and size of knots, the more expensive the wood will be.



>> Joined wood

To ensure the highest quality in the selection of our wood, it is sorted meticulously before planing. Planks that feature defects on both sides are taken out. Defects (knots, cracks, flashes) are removed and the planks are joined together (see the image above).

This is why it is not unusual to find joined elements in a wooden pool, it in no way penalises the mechanical properties of the wood. For the same reason, imperfections on the interior surface of the pool (knots, cracks, flashes) are entirely acceptable.



Storage. If you do not intend to assemble your pool immediately, you should store it without opening it in a well-ventilated room, or failing this, in an area protected from humidity and sunlight. If, however, you were obliged to unpack your pool, redo and restrap the pallet. Once the pallets are undone, the kit must be assembled within 24 to 48 hours.

